

Article number: 2301170525

Description: E+G Handwheel
VDT.125+IR A-12

Measures

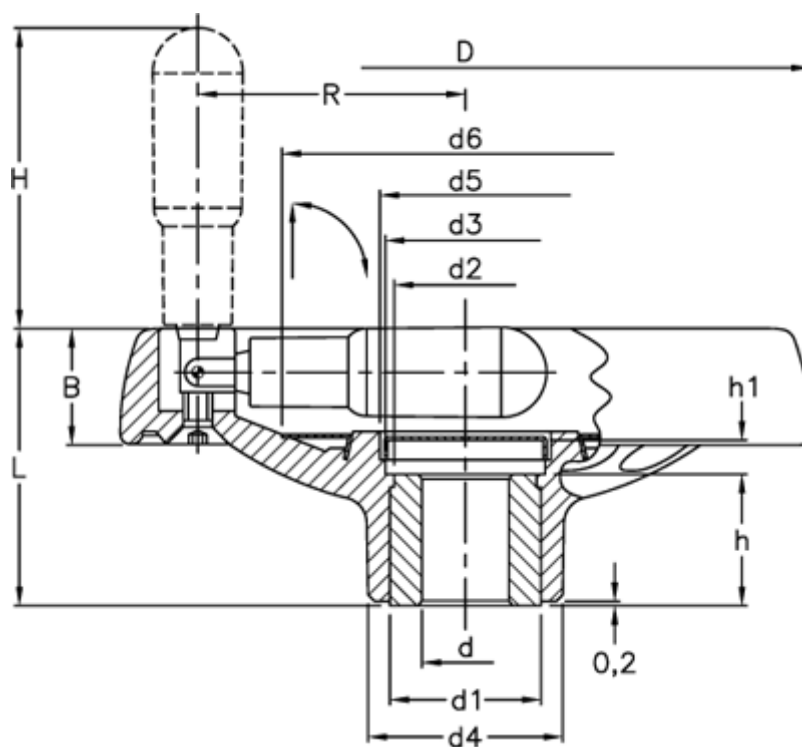

B	= 24	d6	= 70
C (N m)	= 200	d H7	= 12
D	= 125	H	= 65
d1	= 26	h	= 27
d2	= 24	h1	= 7.0
d3	= 28	L	= 57
d4	= 36	L (J)	= 23
d5	= 31	R	= 47